

# ATV WAGON

BY BOSSKI

*High Performance ATV Trailers*



## **800 UT-X** OWNERS MANUAL & ASSEMBLY INSTRUCTIONS

### **CAUTION:**

Read Rules for Safe  
Operation and Assembly  
Instructions Carefully



**NEED HELP? Please visit us at [www.ATVWAGON.com](http://www.ATVWAGON.com)**

# Safety Rules

Remember, any piece of equipment like an ATV trailer can cause injury if operated improperly or if the user does not understand how to operate the equipment. Exercise caution at all times when using your tow vehicle and tow trailer.



**LOOK FOR THIS SYMBOL TO POINT OUT IMPORTANT SAFETY PRECAUTIONS. IT MEANS -- ATTENTION! BECOME ALERT! YOUR SAFETY IS INVOLVED.**

## **Please exercise caution at ALL times when using the trailer on your tow vehicle:**

- Read this owners manual before attempting to assemble or operate trailer.
- Read the tow vehicle's owners manual and know how to operate your tow vehicle before using the trailer.
- Do not transport people on or inside the trailer. The transport of people puts their lives at risk and may be illegal as the trailer has not been designed to carry passengers.
- Do not allow adults to operate tow vehicles or trailers without proper instructions and experience.
- Never allow children to operate the tow vehicle or the trailer.
- Recommended tow vehicle engine size is 350 cc or larger with four-wheel drive in order to allow safe operation when towing the trailer.
- Use caution when towing the trailer over rough terrain and hillsides to prevent rolling over and loss of control. Be careful towing the trailer in icy, wet, or snowy conditions which could impair the braking ability of the trailer and the tow vehicle.
- Tow Vehicle braking and stability may be affected when towing this trailer.
- Using the trailer with a heavy load may inhibit the towing capacity of the tow vehicle. Do not exceed the maximum towing capacity of your vehicle. Check the vehicle's owners manual on tow capacity limitations.
- Before operating vehicle on any sloped surface or hill, refer to the safety rules in the vehicles owners manual on proper operation on slopes. Use extreme caution on steep slopes.
- Do not tow trailer on highways or on public thoroughfares. The trailer is designed for off road use only.



**CAUTION: VEHICLE BRAKING AND STABILITY MAY BE AFFECTED WITH THE ADDITION OF THIS TRAILER. BE AWARE OF CHANGING CONDITIONS ON SLOPES AT ALL TIMES.**



**CAUTION: AN IMPROPERLY COUPLED TRAILER CAN RESULT IN DEATH OR SERIOUS INJURY. TIGHTEN THE COUPLER ADJUSTMENT REGULARLY.**

## **WARNING**

Driving too fast for conditions can result in loss of control and cause death or serious injury.

- Decrease your speed as road, weather and lighting conditions deteriorate.

## **WARNING**

Improper tire pressure can result in a blowout and loss of control, which can lead to death or serious injury.

- Be sure tires are inflated to pressure indicated on sidewall before towing trailer.

## **WARNING**

An improperly coupled trailer can result in death or serious injury.

Do not tow the trailer until:

- The coupler is secured and locked to hitch;
- **The coupler tightness is adjusted for a 2 " ball.**
- Tires and wheels are checked;
- The trailer brakes (if applicable) are checked;
- The load is secured to the trailer; and
- The trailer lights are connected and checked

## **WARNING**

Lug nuts are prone to loosen after initial installation, and if improperly tightened can lead to death or serious injury.

- Check lug nuts for tightness on a new trailer or when wheel(s) have been remounted after the first 10, 25 and 50 miles of use. Tighten lug nuts before each use.

## **WARNING**

An overloaded trailer or improper distribution of load weight or shifting cargo can result in loss of control of the trailer, leading to death or serious injury.

- Do not exceed the trailer Gross Vehicle Weight Rating (GVWR).
- Tie down all loads with proper sized fasteners, ropes, straps, etc.

Be sure to:

- Distribute the load front-to-rear and provide proper tongue weight;
- Distribute the load evenly, right and left, to avoid tire overload; and
- Keep the center of gravity low.

## **WARNING**

Improper electrical connection between the tow vehicle and the trailer will result in inoperable lights and electric brakes, and can lead to collision.

Before each use:

Check tail/brake light functions properly

Check electric brakes (if applicable) function properly by operating the brake controller on the tow vehicle.

### LIMITED WARRANTY TO CONSUMERS

Bosski warrants the goods to be new and free from material defect for one (1) year from the date of Bosski's delivery of the goods to Buyer. This warranty will be satisfied by Bosski's repairing the goods or furnishing replacement goods or parts, at its option. To take advantage of this warranty, Buyer must immediately notify Bosski of the claimed defect. Bosski shall have no obligation under this warranty for (a) goods which have been repaired or altered by any party other than Bosski, and or (b) defects which result from misuse, accident, or improper connection of the goods to a tow vehicle, and or (c) commercial use of the product. **THIS IS BUYER'S EXCLUSIVE REMEDY UNDER WARRANTY. BOSSKI DISCLAIMS ALL OTHER WARRANTIES, EXPRESS OR IMPLIED, INCLUDING BUT NOT LIMITED TO WARRANTIES OF MERCHANTABILITY, FITNESS FOR A PARTICULAR PURPOSE, AND AGAINST INFRINGEMENT. THIS WARRANTY IS NOT TRANSFERABLE.**

# ATV WAGON

BY BOGGI

## High Performance ATV Trailers

**Congratulations!** You have purchased the best, and most versatile pull-behind ATV trailer on the market today.

Please follow the enclosed instructions closely, and your assembly should be effortless and quick. For your convenience we have pre-assembled and packaged as many components as possible.

All torque settings listed in this manual are based on a dry, non lubricated bolt. Over-torquing may result in bolt failure, and under-torquing may result in nuts working loose.



**CAUTION:** After first 5 hours of use check all fasteners for appropriate tightness. Tighten wheel lug nuts before each use.

Be sure to repack your wheel bearings as needed with a high quality grease. Repack more often under high use or in wet conditions. Check the website [www.atvwagon.com](http://www.atvwagon.com) for the latest updates, tips, and advice.

### RECOMMENDED TOOL CHECK LIST



9mm, 13mm,  
18mm & 19mm  
Wrenches



Torque Wrench and/or Ratchet



4 inch extension



18mm, 19mm, & 13/16"  
Sockets. A 13/16 " lug wrench  
could replace the socket



**BEFORE OPERATING YOUR ATV WAGON, read, understand, and follow the safety rules on page 2 and the warnings listed on page 3 as well as the cautions listed throughout the manual.**



# ATV WAGON PARTS LIST

Numbers in ( ) indicate quantity

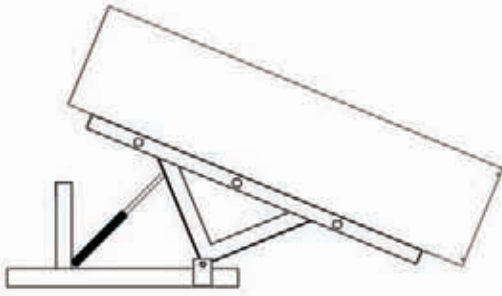

**(1)–Trailer Body and Frame Assembly**



**(1) – Torsion Axle Assembly**



**(2)–Tire and Wheel Assembly**

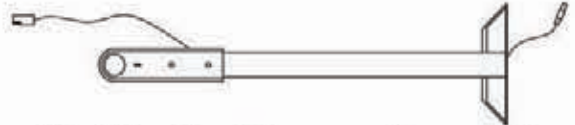

**(1)–Trailer Tongue Assembly**



**(1)–Handle Assembly**

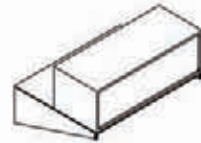

**(1) -Tail Light Assembly**



**(1) -ATV Wiring Harness & Connectors**

## **HARDWARE CHECK LIST**



**(19) 12mm Washer**



**(10) 12mm Nut**



**(8) 12mm Tapered Nut**



**(10) 6mm x 70mm bolts**



**(2) 12mm x 38mm Bolt**



**(6) 12mm x 76mm Bolt**



**(2) 12mm x 89mm Bolt**



**(10) 6mm x 70mm**



**(12) 6mm Nuts**

# TRAILER ASSEMBLY

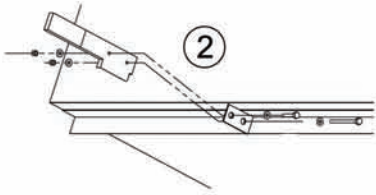

**WARNING:**  
THE TRAILER BED IS UNDER PRESSURE.  
WHEN YOU PULL THE BED LATCH PIN,  
THE BED WILL AUTOMATICALLY DUMP.  
USE EXTREME CAUTION OR AN INJURY  
COULD OCCUR.

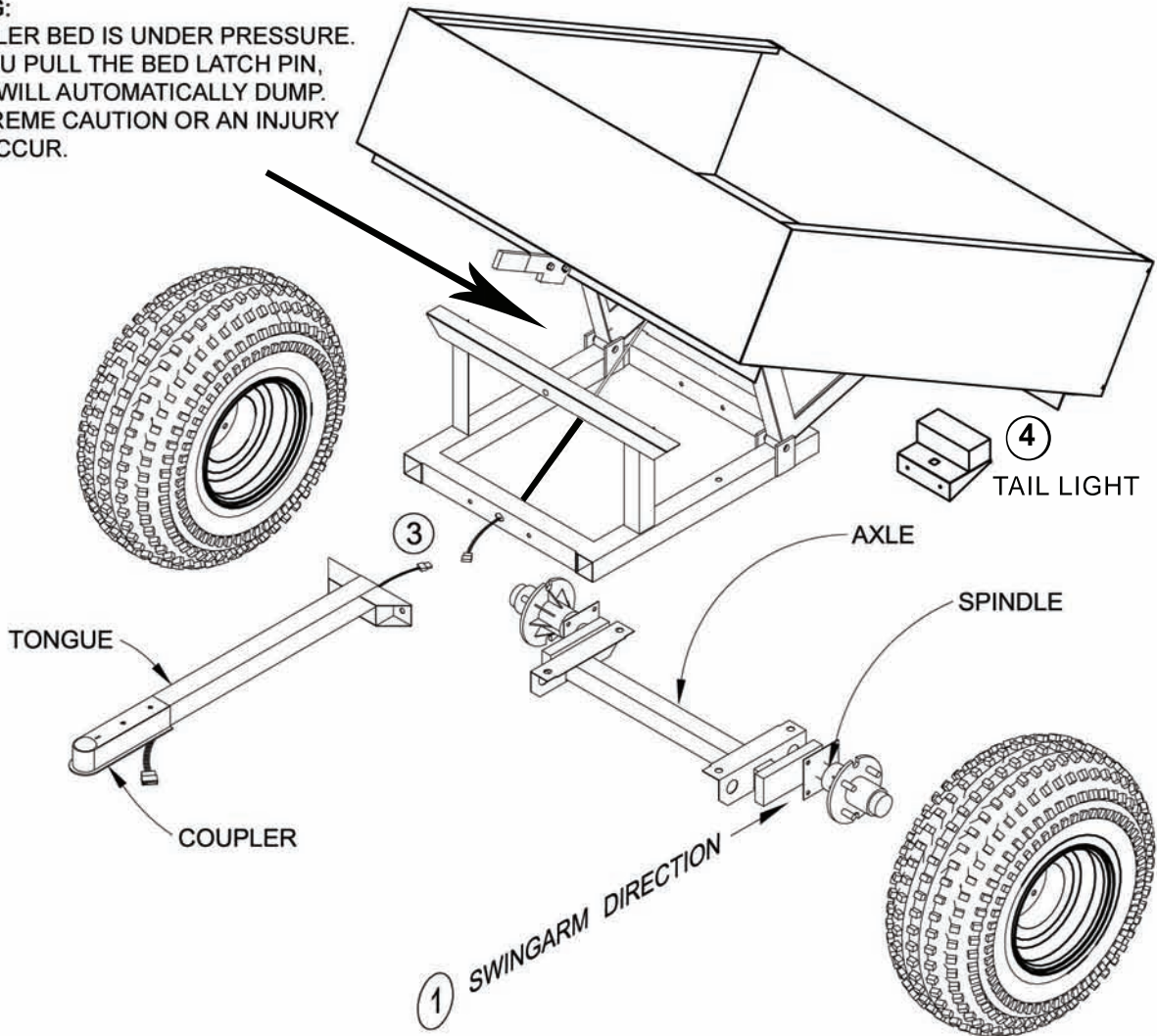

**BEFORE OPERATING YOUR ATV WAGON, read, understand, and follow the safety rules on page 2 and the warnings listed on page 3 as well as the cautions listed throughout the manual.**

## ATV WAGON ASSEMBLY INSTRUCTIONS:

Install the axle to the frame with (4) 12mm x 76mm bolts, each with (2) washers and (1) nut. Tighten to 50 to 71 ft-lbs (68 to 96 nm).

It is important that the axle is installed with the swingarms trailing the main axle beam, as shown in the assembly diagram (1)

Mount each wheel/tire assembly to the axle hubs with the 4 tapered nuts.

To insure that the wheels and tires are mounted correctly, they should be installed with the valve stems facing away from the frame.

Tighten the nuts gradually, alternating between nuts opposite each other to assure even seating of the wheel onto the axle. Tighten nuts to 50 to 71 ft-lbs (68 to 96 nm).

---

Install the latch/handle (2) to the front of the bed using (1) 38mm bolt with (2) washers and (1) nut in the front hole. Repeat the steps for the back hole using (1) 38mm bolt with (2) washers and (1) nut. Tighten bolts to 50-71 Ft-lbs (68 to 96 Nm).

---

On the tongue assembly, connect the male electrical connectors to the female electrical connectors, ensuring that the colors of the wires match on both connectors. (3)

After making the electrical connections, push them into the tongue of the trailer so the wires do not become pinched between the frame and the tongue.

Install the tongue assembly to the frame with (4) 12mm x 76mm bolts, each with (2) washers and (1) nut. Tighten to 50 to 71 ft-lbs (68 to 96 nm).

---

Mount the tail light assembly (4) to the frame using (2) 6mm x 70mm, each with (2) washers and (1) nut.





## ATV WIRING INSTALLATION

The ATV wiring harness has a 4-pole connector at one end and bare end wires at the other end. This harness connects to the ATV's taillight and battery. Splice these wires, using the supplied connectors, into the appropriate ATV wires, as shown below. For additional assistance, please refer to your ATV owner's manual or ATV wiring schematic. Seal all splices to insure that water does not corrode or short the electrical wiring.

Next route the connector-end of the wire to the rear of the ATV. Be sure to leave enough extra wire to accommodate the turning requirements when pulling your ATV Wagon.

When you are ready to use the ATV Wagon trailer, plug the connector end into the 4-pole connector at the trailer coupler.

### WIRING HARNESS-TO-ATV

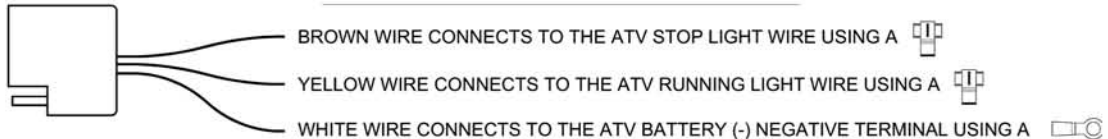

Note: Some models may contain a 4-pole connector with an extra black wire. Please ignore the Black wire.

### OPERATING THE STRONG ARM DUMP SYSTEM

1. Grasp handle firmly and press down

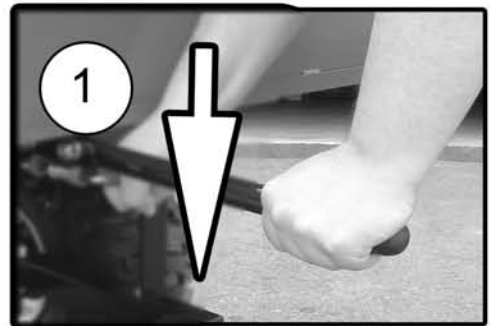

2. With second hand, pull dump bed latch pin towards you

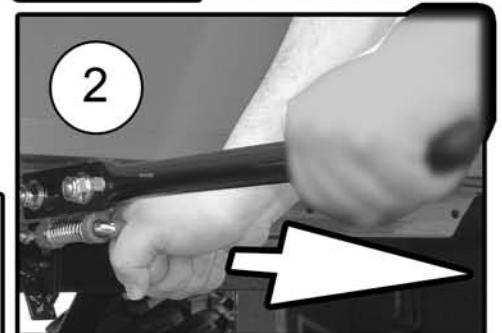

**WARNING:** THE TRAILER BED IS UNDER PRESSURE. WHEN YOU PULL THE BED LATCH PIN, THE BED WILL AUTOMATICALLY DUMP. USE EXTREME CAUTION OR AN INJURY COULD OCCUR.

3. Control the dump motion using the arm used in step 1

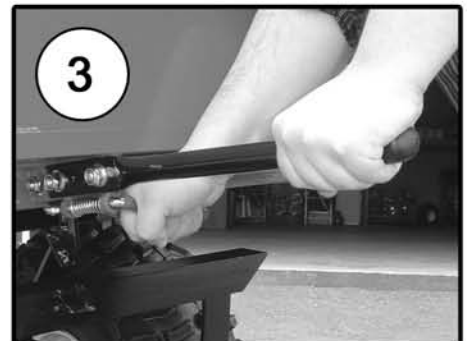



# WIRING SCHEMATIC FOR 800 UT-X

ATV SIDE

ATV WAGON SIDE

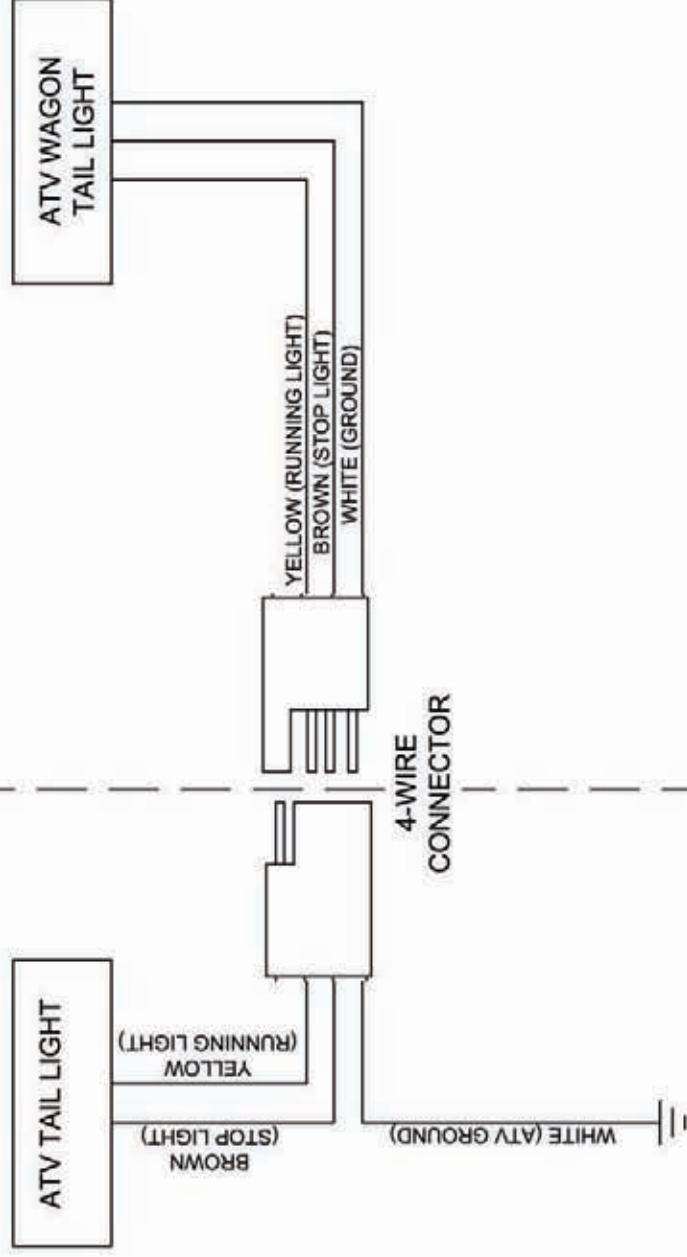



**ATV WAGON**  
*BY BOSSKI*  
*High Performance ATV Trailers*

**NEED HELP?**

**Please visit us at [www.ATVWAGON.com](http://www.ATVWAGON.com)**

